

IMPACT ACOUSTIC®

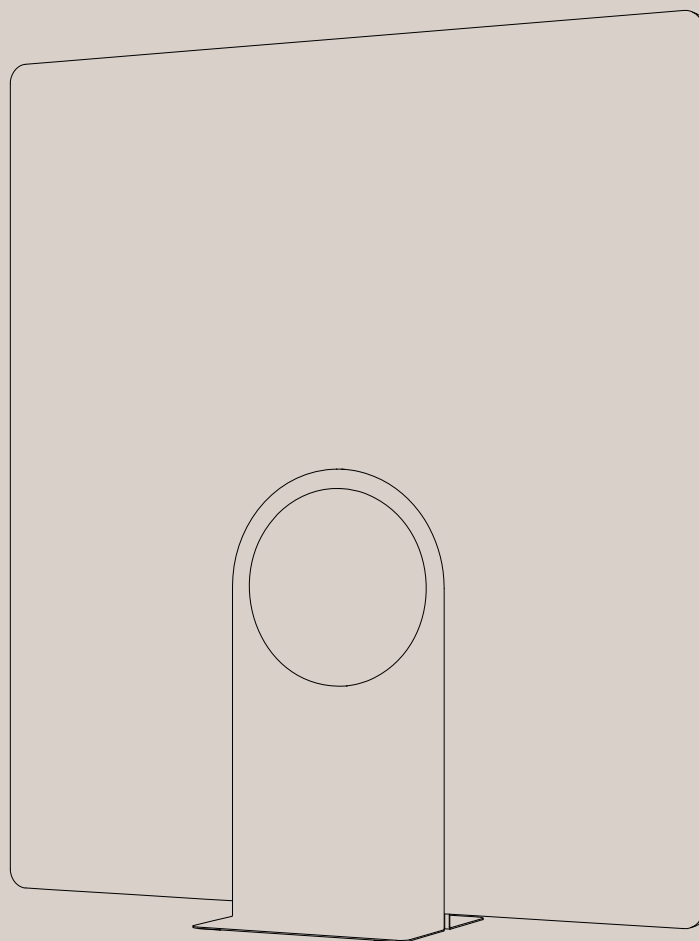

Asto

Standing Partition

1600 x 1800 x 24

743.24.12.000.00
743.24.12.000.10
743.24.12.000.11
743.24.12.000.12
743.24.12.000.13

TECHNICAL DATA SHEET

Asto

Standing Partition

Article Number

743.24.12.000.00

Dimensions

Length	1600mm	63"
Width	1800mm	70.86"
Thickness	24mm	0.94"

Information

1 pc., incl. Centerbase 900mm (H), RAL 9005

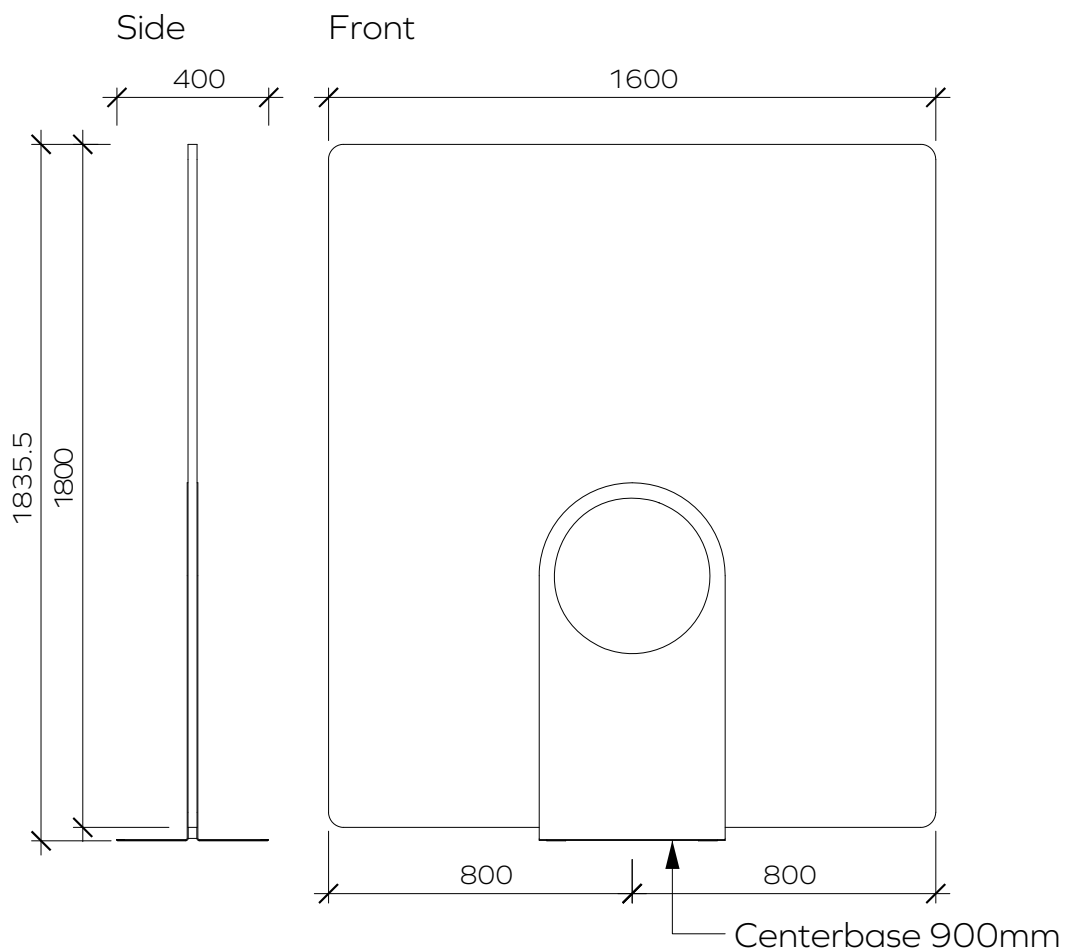
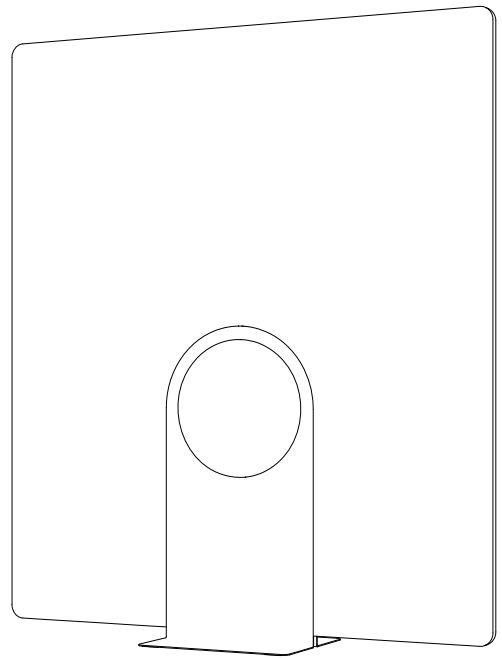

Asto

Standing Partition

Perforation

743.24.12.000.10

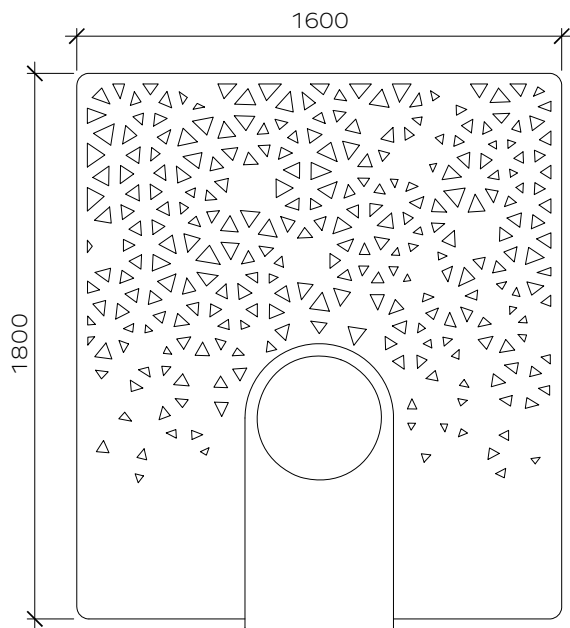

743.24.12.000.11

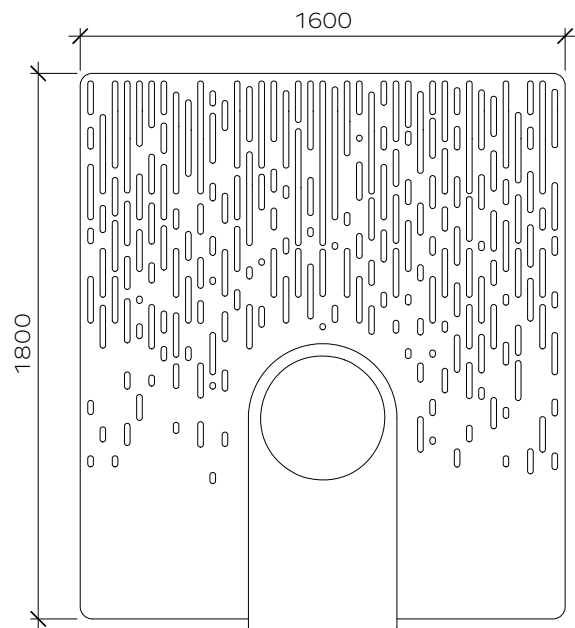

743.24.12.000.12

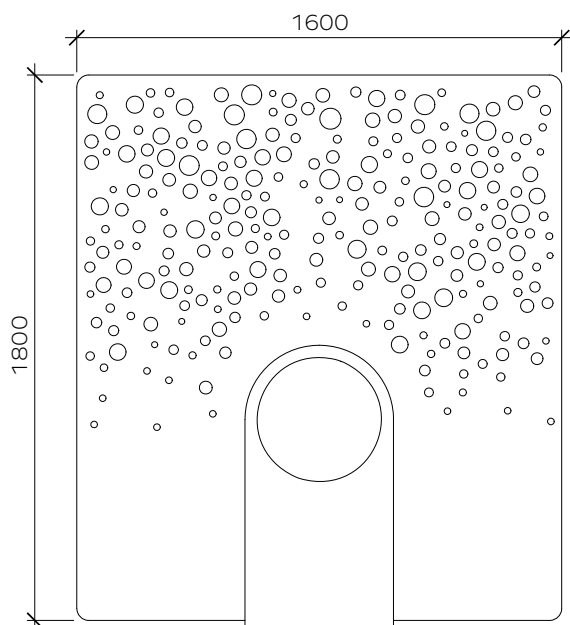

743.24.12.000.13

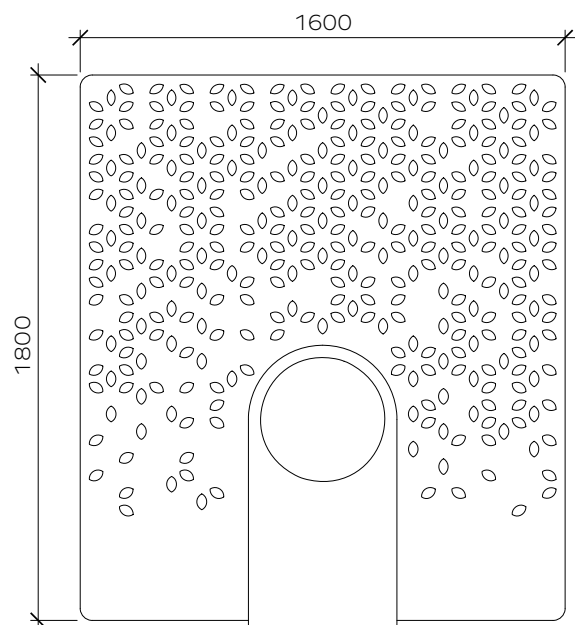

Asto

Standing Partition

Acoustic Technical Specifications

Asto Standing Partition 1600 x 1800 x 24mm

Frequency (Hz)	125	250	500	1000	2000	4000
Asto 1600 x 1800 (plain)	1.14	2.01	2.58	3.74	4.32	4.60
Asto 1600 x 1800 (perforation)	0.77	1.22	2.08	3.45	4.09	4.65

Sound Absorption Coefficient (α_s) according to EN ISO 354 Universität Stuttgart – Institut für Akustik und Bauphysik IABP

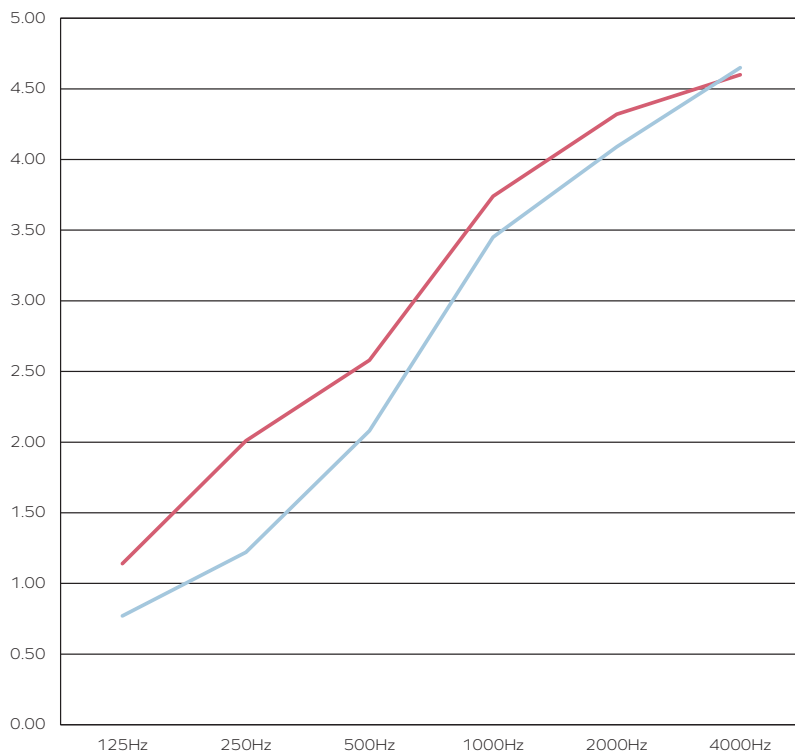

- Asto 1600 x 1800 (plain)
- Asto 1600 x 1800 (perforation)

The graph represents the sound absorption coefficients (α_s) in the third octave band center frequencies. Measurement used Pink Noise as excitation signal in a reverberant room.

ARCHISONIC®

Colours

Quiet Neutrals

12mm & 24 mm

These shades work in harmony with natural textural materials and soften industrial environments. From light to dark and cool to warm, these are the foundations of any scheme where longevity and a mood of calm is desired.



Snow White
500



Cloud
103



Smoke
442



Ground
108

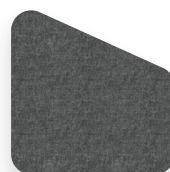

Charcoal
542

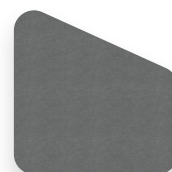

Slate
444



Raven
550

Warm Naturals

12mm & 24 mm

Combinations of lighter toned neutrals and pinks have a gently soothing and restorative effect while the more saturated hues make perfect environments for relaxation.



Warm Stone
105



Milk
404



Shell Pink
102

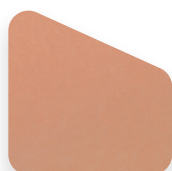

Soft Coral
516



Terracotta
239



Garnet
724

ARCHISONIC®

Colours

Living Greens

12mm & 24 mm

From the cool greens of forests to the yellowed aspect of young wheat, we see Living Greens breathing life into indoor spaces, and an essential palette for the future. Use in tonal layers brings the depth and diversity of green, while a single note can provide an amplifying backdrop to a biophilic space.

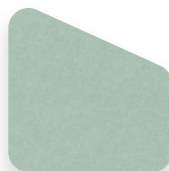

Spearmint
706



Succulent
712



Moss
439



Nordic Pine
311



Grove
317

Elemental Blues

12mm & 24 mm

These blues work perfectly both as familiar single hues and in effortless tonal layers to create an immersive environment for focus or restoration.



Ice Blue
304



Winter Sky
410



Marine Blue
864



Pacific Ocean
432



Midnight
810

ARCHISONIC®

Colours

Soothing Pastels

12mm & 24 mm

With tonal duos of pink and blue and green, this perfectly balanced group is designed for peaceful plays on light and shade and playful contrast. While the lightest tones have a dreamlike quality, their deeper counterparts add a subtle grounding.



Shell Pink
102

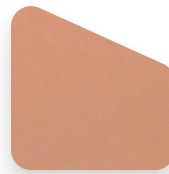

Soft Coral
516



Ice Blue
304



Winter Sky
410

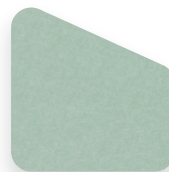

Spearmint
706



Succulent
712

Elegant Darks

12mm & 24 mm

While colour can create a mood, it is the depth or lightness of a hue that truly defines the emotion. While each hue has the strength to stand alone, beautiful effects can be achieved with harmonized pairs.



Garnet
724



Marine Blue
864



Midnight
810



Nordic Pine
311



Raven
550

ARCHISONIC®

Colours

Energetic Brights

12mm & 24 mm

There are no rules here with endless possibilities for clashing contrasts or surprising highlights. For a sophisticated use of energetic colour, take a single hue and colour match contrasting textiles and solid surfaces.



Pacific Ocean
432



Moss
439



Sunshine
846



Electric Orange
464



Hot Pink
140

Primary Play

12mm & 24 mm

The primary story happens when all three main colours are used together, with varied proportions creating differing moods. As with the Energetic Brights palette, combine with coordinating-coloured textiles and solid surfaces.



Snow White
500



Charcoal
542



Sunshine
846



Poster Red
662



Marine Blue
864

ARCHISONIC® Material

Composition

100% PET (60% certified post-consumer content)

Material Reutilisation

24mm

88 PET bottles/m²

12mm

53 PET bottles/m²

Density

24mm

4000 g/m² (+/-10%)

12mm

2400 g/m² (+/-10%)

Dimensions Raw Panels

24mm

1800 x 2400 x 24mm

70" x 94" x 0.94" (+/-7%)

12mm

1200 x 2800 x 12mm

47" x 110" x 0.47" (+/-7%)

Fire Test

B-s1, d0

DIN EN 13501-1

Class A

ASTM E84

VOC Emission

A+

28 Days French Regulation

Pass

14 Days CDPH/EHLB



Care Instructions

PET fibres do not provide a breeding ground for bacteria and other germs. The dyed-through fibres do not bleach out even when using aggressive cleaning agents and disinfectants. Alcohols, aldehydes or active chlorine can be used for cleaning.

For daily cleaning we recommend alcohol solution (75%), e.g. Pantasept. In case of contamination by dust or fluff, use feather duster or a regular vacuum cleaner. For heavy dirt, treat the material with hydrogen peroxide.

Declare.

**ARCHISONIC®
Impact Acoustic AG**

Final Assembly: Lucerne, Switzerland

Life Expectancy: 30 Year(s)

End of Life Options: Salvageable/Reusable in its Entirety, Take Back Program, Recyclable (98.5%)

Ingredients:

PET: Polyethylene Terephthalate; **Phosphorus flame retardant:** Phosphorus; **N, N'-Ethylene bis(stearamide):** Octadecanamide, N,N'-1,2-ethanedilylbis-; **Stearic acid:** Stearic Acid; **Titanium dioxide:** Titanium dioxide

Living Building Challenge Criteria: Compliant

I-13 Red List:

LBC Red List Free % Disclosed: 100% at 100ppm
 LBC Red List Approved VOC Content: Not Applicable
 Declared

I-10 Interior Performance: CDPH Standard Method v1.2-2017

I-14 Responsible Sourcing: Not Applicable

IMA-0001
EXP. 01 AUG 2023
Original Issue Date: 2022

MANUFACTURER RESPONSIBLE FOR LABEL ACCURACY
INTERNATIONAL LIVING FUTURE INSTITUTE™ living-future.org/declare

ARCHISONIC®

Material

Matching NCS Colour Codes

Developed by Colour Hive

Quiet Neutrals	500	103	442	108	542	444	550
NCS Code	S 0300-N	S 1002-B	S 3005-R80B	S 5005-Y20R	S 7502-B	S 4500-N	S 8500-N
Warm Naturals	105	404	102	516	239	724	
NCS Code	S 3010-Y50R	S 0502-Y	S 0510-R30B	S 2020-Y90R	S 4040-Y70R	S 5040-R10B	
Living Greens	706	712	439	311	317		
NCS Code	S 1010-B90G	S 3020-B30G	S 2040-G40Y	S 5030-G10Y	S 7020-G30Y		
Elemental Blues	304	410	864	432	810		
NCS Code	S 0510-B	S 2020-R90B	S 4050-R70B	S 3040-B	S 7020-R70B		
Soothing Pastels	102	516	304	410	706	712	
NCS Code	S 0510-R30B	S 2020-Y90R	S 0510-B	S 2020-R90B	S 1010-B90G	S 3020-B30G	
Elegant Darks	724	846	810	311	550		
NCS Code	S 5040-R10B	S 4050-R70B	S 7020-R70B	S 5030-G10Y	S 8500-N		
Energetic Brights	432	439	846	464	140	540	
NCS Code	S 3040-B	S 2040-G40Y	S 1040-Y10R	S 0580-Y70R	S 2060-R20B	S 5040-R40B	
Primary Play	500	542	846	662	864		
NCS Code	S 0300-N	S 7502-B	S 1040-Y10R	S 1080-R	S 4050-R70B		

These NCS codes are the closest visual match available and may not be exact to blended fibres.

Colour fastness

Class 6

ISO 105-B02:A1

Colour and surface deviation

ARCHISONIC® is manufactured to the highest quality standards, but slight colour and surface variations caused by the high percentage of recycled fibers are an unavoidable part of the product characteristics and do not claim warranty. Please request a free sample box to verify the colours.

ARCHISONIC® Material

Light Reflection

Hochschule Luzern – Institut für Gebäudetechnik | Energie

HSLU Hochschule
Luzern

Quiet Neutrals	500	103	442	108	542	444	550
Reflectance p	61.9%	51.4%	34.6%	22.5%	6% 1	7.9%	2.6%
Warm Naturals	105	404	102	516	239	724	
Reflectance p	27.5%	59.3%	55.2%	34.1%	10.3%	4.1%	
Living Greens	706	712	439	311	317		
Reflectance p	51.7%	27.7%	33.2%	10.3%	9.6%		
Elemental Blues	304	410	864	432	810		
Reflectance p	60%	32%	9.5%	15.2%	3.7%		
Soothing Pastels	102	516	304	410	706	712	
Reflectance p	55.2%	34.1%	60%	32%	51.7%	27.7%	
Elegant Darks	724	846	810	311	550		
Reflectance p	4.1%	9.7%	3.7%	10.3%	2.6%		
Energetic Brights	432	439	846	464	140	540	
Reflectance p	15.2%	33.2%	44.3%	26.8%	12.2%	5.5%	
Primary Play	500	542	846	662	864		
Reflectance p	61.9%	6%	44.3%	12.5%	9.5%		

Sustainability



MINIMUM 60% RECYCLED CONTENT
POST-CONSUMER

Supported by



Climate-KIC is supported by the
EIT, a body of the European Union

**#We
Make An
Impact**

connect@impactacoustic.com | www.impactacoustic.swiss